

Model NO: TSS2020R9_NA
TSS2020R9_EU

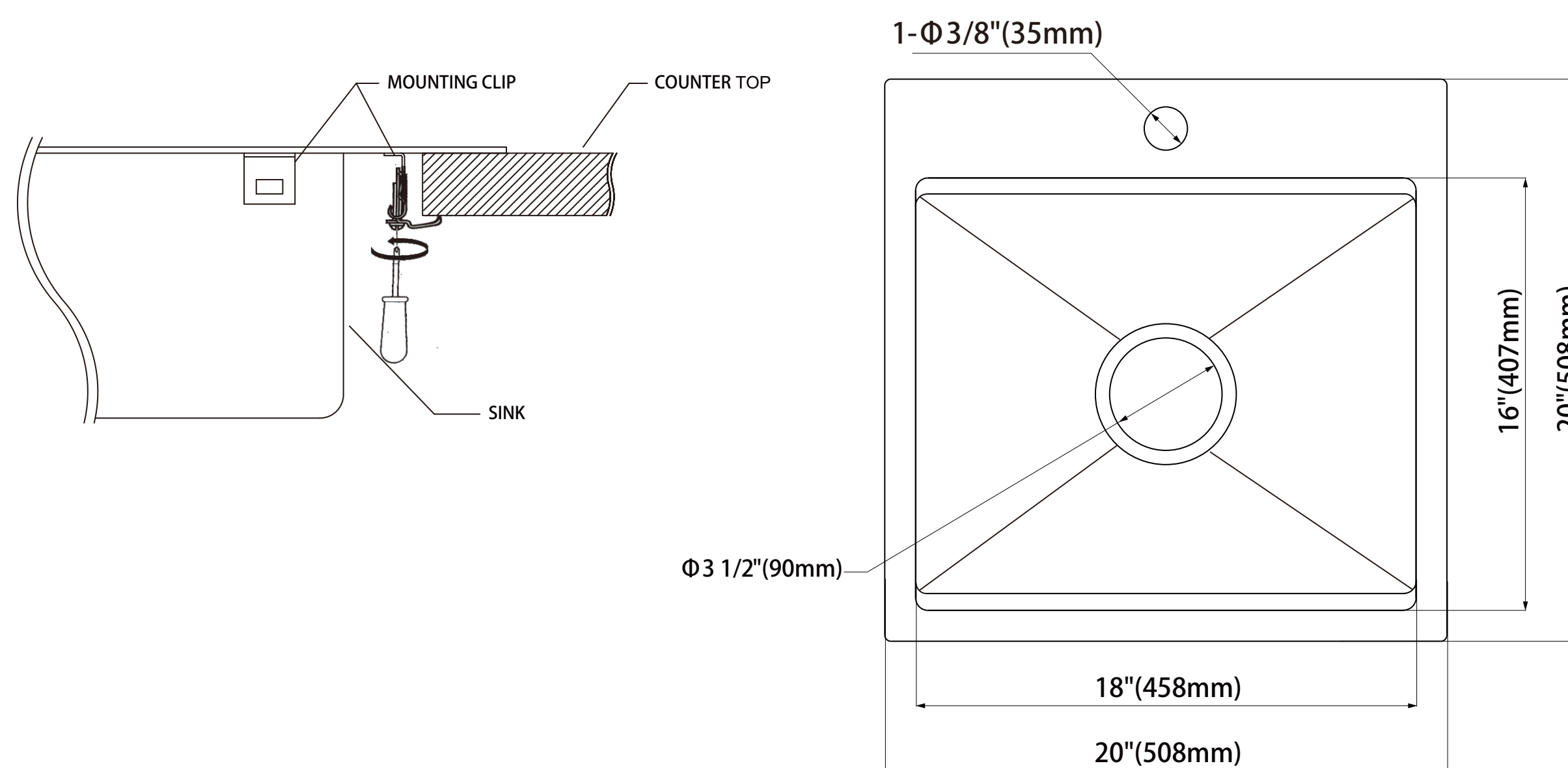

Any questions.
PLS feel free to contact us.
We'll reply you within 24 hours.

NOTE: Cutout template is provided as a guide ONLY and must be checked against actual sink to verify correct fit.

Hole size: 488*488mm Fillet: R10 (1:1)
Applicable model : TSS2020