

Model NO: RV1621R9NH_NA
RV1621R9NH_EU

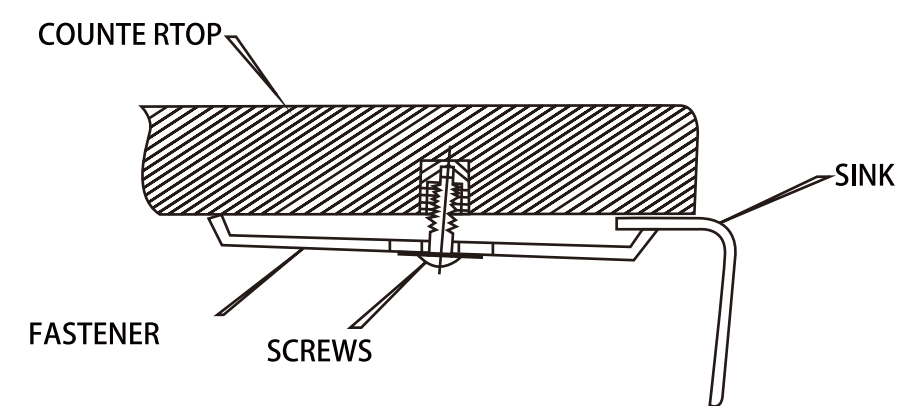
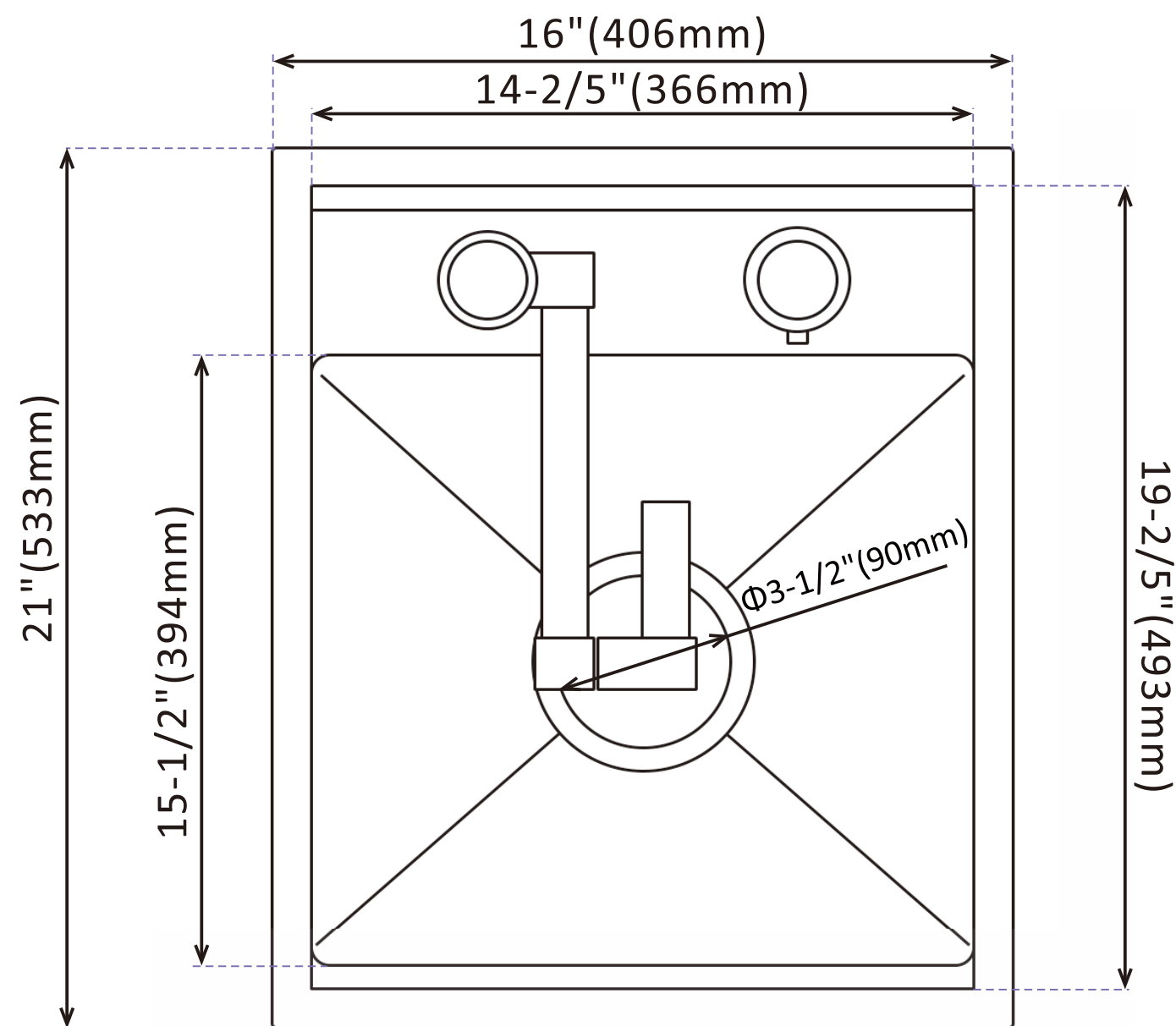

Please tear perforated edge for zero / flushed reveal 14-2/5" * 19-2/5" (366mm*493mm)

Please use outer edge for positive reveal 3/8" (Topmount template) 14-19/25" * 19-19/25" (375mm*502mm)

Any questions.
PLS feel free to contact us.
We'll reply you within 24 hours.

NOTE: Cutout template is provided as a guide ONLY and must be checked against actual sink to verify correct fit.

Hole size:375mm*502mm Fillet:R10(1:1) Applicable model:RV1621R9NH-NA