

Model NO: RV1518R9NH_NA
RV1518R9NH_EU

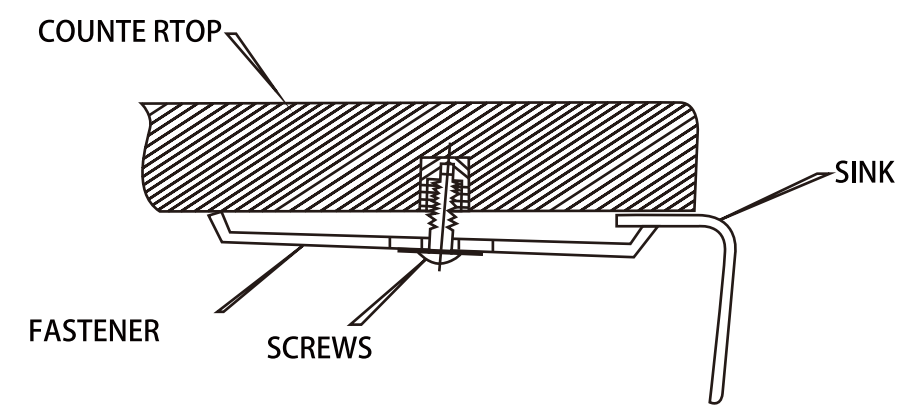
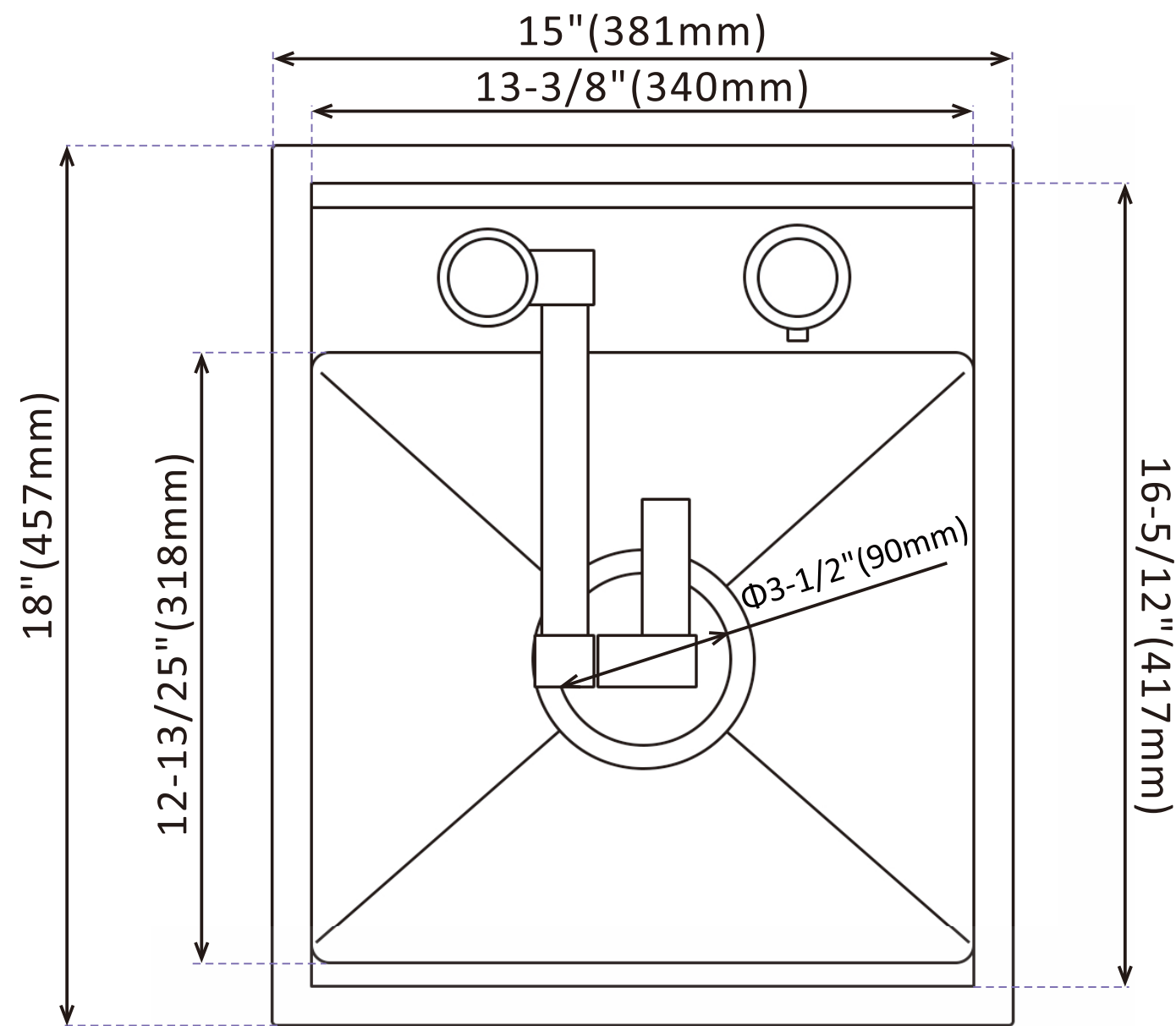

Please tear perforated edge for zero / flushed reveal 13-3/8" * 16-5/12" (340mm*417mm)

Please use outer edge for positive reveal 3/8" (Topmount template) 13-3/4" * 16-10/13" (349mm*426mm)

Any questions.
PLS feel free to contact us.
We'll reply you within 24 hours.

NOTE: Cutout template is provided as a guide ONLY and must be checked against actual sink to verify correct fit.

Hole size:349mm*426mm Fillet:R10(1:1) Applicable model:RV1518R9NH-NA